

ROW CROPS

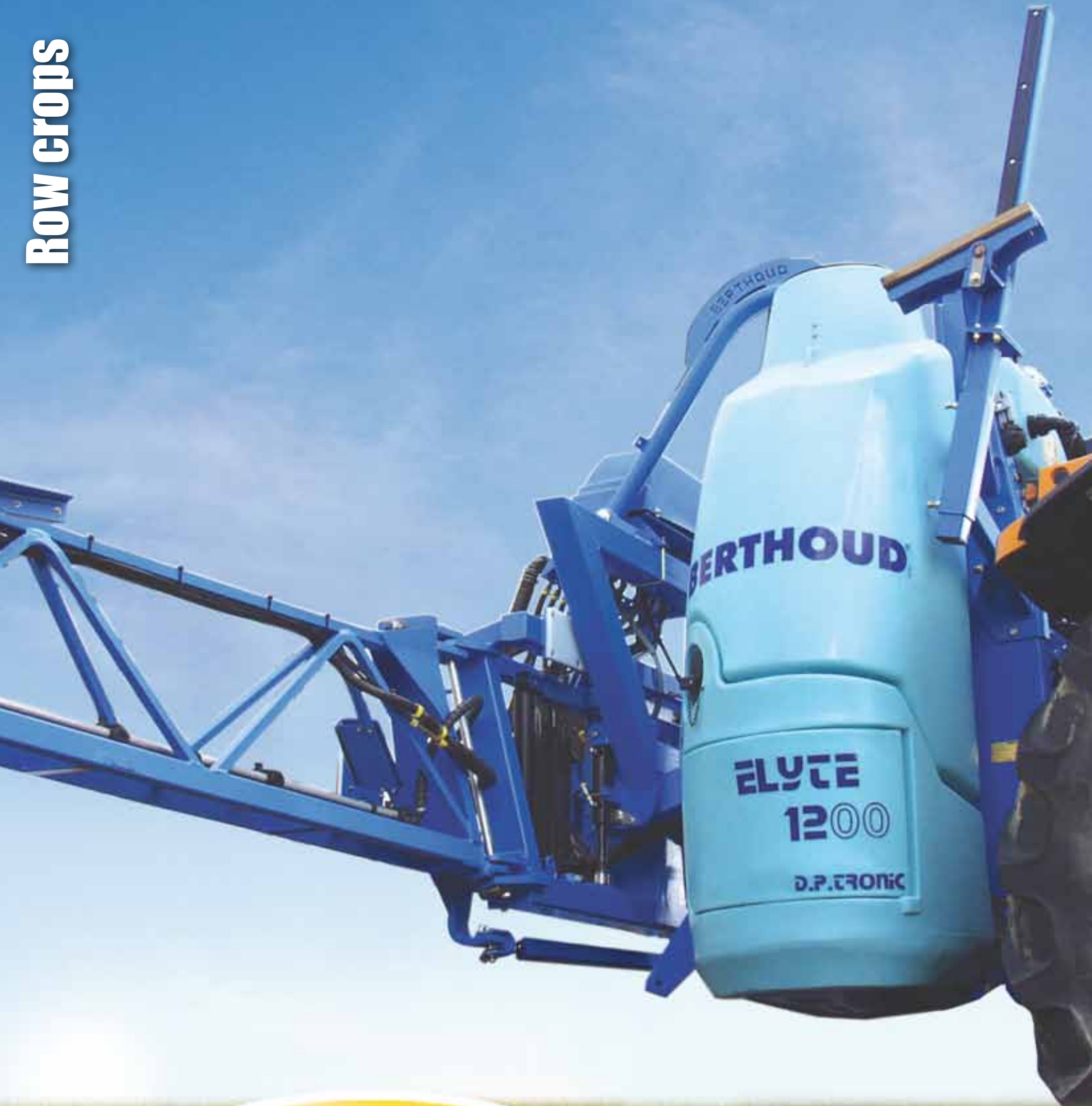

**Mounted
units**

1000 L

1200 L

1600 L

BERTHOUD®
Forward together

ELYTE

Design & innovation



A particularly novel design, the new mounted sprayer, the Elyte is a complete **technological package** with unrivalled levels of performance in its category. **Safety, ease of operation, accuracy of application, and respect for the environment** are all paramount.

Available in 3 capacities, 1000, 1200 and 1600 litres and with 4 types of regulation systems (Autoregleur, DP Control, DP Tronic and EC Tronic), it can receive spray booms Axiale, RLD, Multis, Ulys, Elypse from 15 to 30 m.

With its curved yet streamline shape, compact and smooth, the new Elyte mounted sprayer catches the eye from the very first moment.

Elyte is a perfect blend of aesthetic design and technical innovation.

THE TANKS AND EQUIPMENT ARE FULLY INTEGRATED INTO THE SPRAY TANK CHASSIS

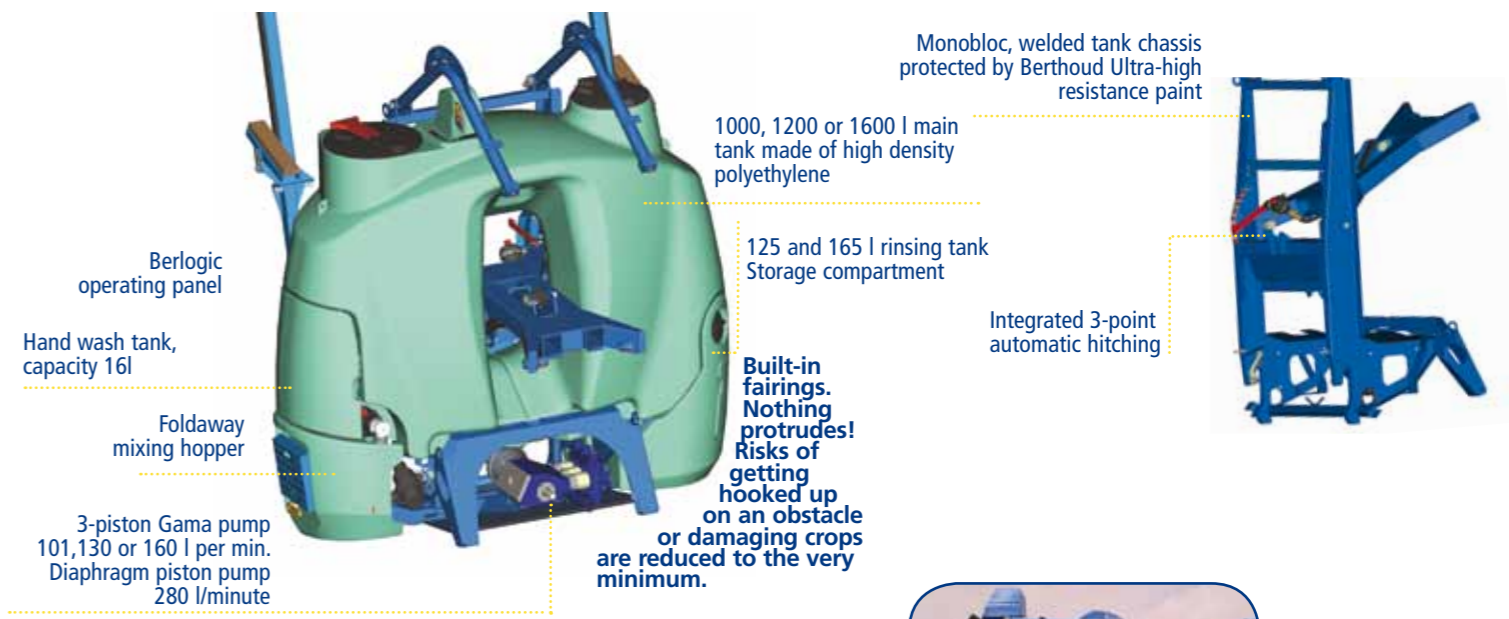

MAXIMUM COMPACTNESS

The centre of gravity at the very front of the unit, the automatic hitching system built into the chassis, minimum overhang and the compactness of the tank, which "sits tight" to the tractor, all help to increase stability and manoeuvrability.



The sides and back of the tank are completely free of any obstacle thus making access to the tank and the spray-boom as easy as possible

THE BOOM IS LIFTED BY MEANS OF A CENTRAL ARM SYSTEM, A PATENTED BERTHOUD INVENTION

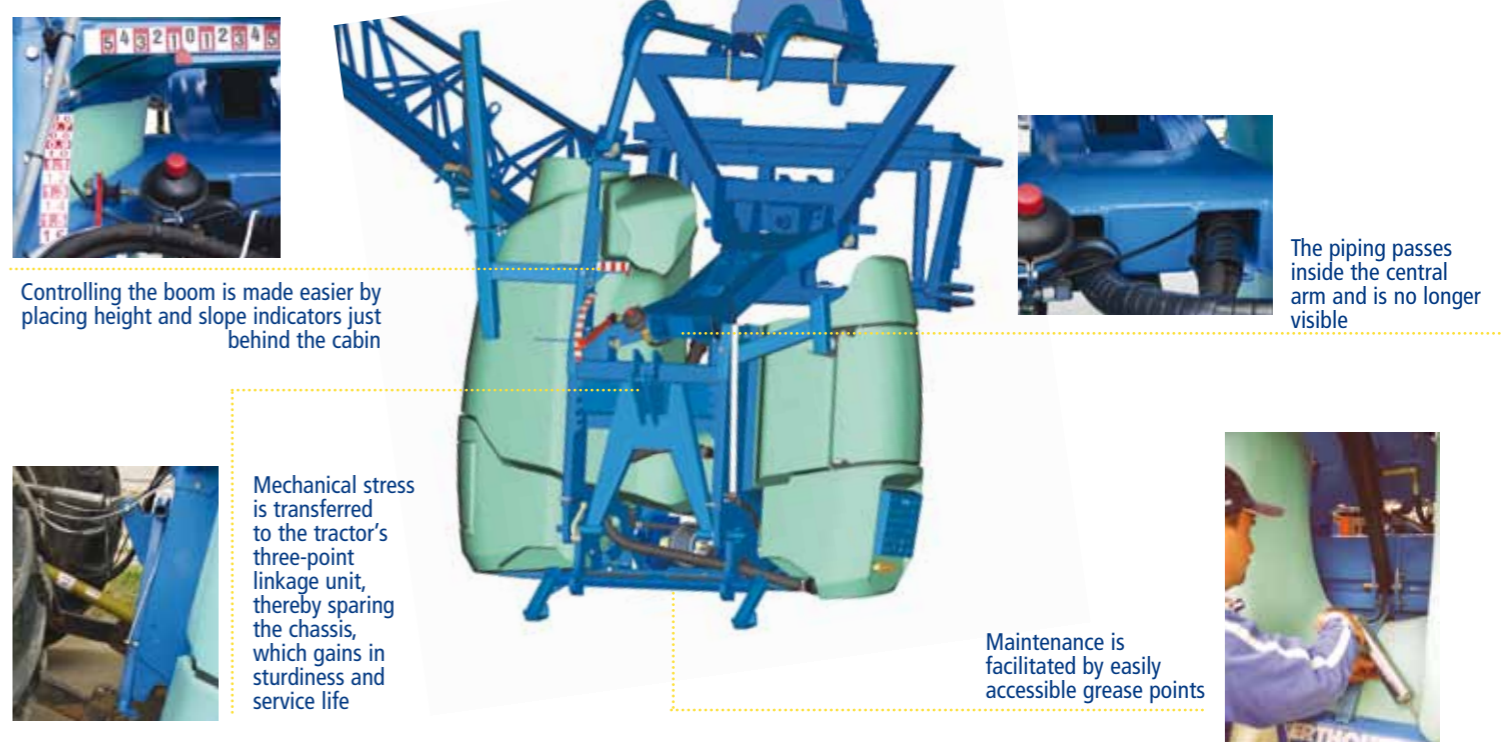

Design in action

FROM HITCHING UP, TO STORING AWAY, THE ELYTE HAS BEEN ENTIRELY DESIGNED FOR MAXIMUM SAFETY AND COMFORT OF OPERATION.

SIMPLE TO OPERATE



Filling

The main tank can be filled: either through the manhole (via the screen filter), which is easily accessible using the foldaway step



or by connecting onto the external suction pipe with a fire hose connection.



Berlogic panel

With the Berlogic panel, operating the unit – filling, mixing, agitating, spraying, etc. – are as rapid and easy as possible.

Agitation

The contents of the tank are agitated by a venturi on the tank return line. The stirring power can be adjusted on the Berlogic panel.

COMFORT AND SAFETY



Hand wash tank

A 16-litre capacity tank for washing hands has been incorporated in the left-hand door of the unit.



Feed hopper

Products can be incorporated effortlessly and in all safety using the foldaway feed hopper and its integrated can rinser.



Sheet metal protection

A sheet metal protection panel can be added to the chassis as an optional extra for avoiding any risk of damaging crops.



Clothing compartment

A clothing compartment is incorporated into the rinsing tank on the right-hand side of the unit.

AUTOMATIC HITCHING



With the automatic hitching system incorporated into the chassis, hitching operations are carried out in all simplicity and under the best possible safety conditions. Hitching the spray unit onto the tractor is made even easier by the long drive shaft going to the pump at the back.



When the unit is being unhitched, foldaway support legs prevent it from toppling forward and damaging any crops.

EASY MAINTENANCE



Standard servicing for the Elyte is extremely simple as its different elements are all easily accessible.

- ① Recovery valve on the Berlogic panel
- ② Easy-to-remove filters
- ③ Pump on the back of the unit
- ④ Grease points on the central lifting arm

40 KM/H ON ROADWAYS

The Elyte's width, no matter what model of boom may be fitted, is less than 2.55 m. So, you are not outside limits for using public roads. You can drive at speeds up to 40 km/h in total safety ...and in total serenity!



Technology at the service of the Good Practice

TODAY, RESPECT OF ENVIRONMENT AND USER SAFETY MUST GO HAND IN HAND WITH EFFICIENT SPRAYING. THIS NOTABLY INVOLVES GOOD PHYTOSANITARY PRACTICE. WITH THE ELYTE, BERTHOUD OFFERS YOU SEVERAL SIMPLE AND NOVEL SOLUTIONS FOR MAKING YOUR TASK EASIER:

MIXING USING CLEAN WATER



The hopper can be fed by the outside suction circuit, which means that clean water can be used for incorporating products and rinsing the hopper or product cans. A system that eliminates any need to rinse the mixing circuit and reduces amounts of phytosanitary effluent.



ACCURATE MEASUREMENT OF THE MIX VOLUME

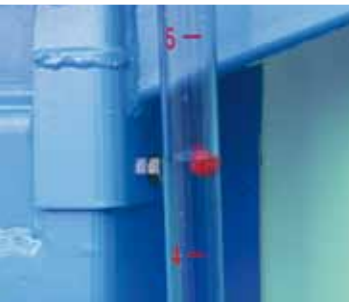

PREPARING THE EXACT VOLUME OF MIX NEEDED FOR TREATING A GIVEN AREA IS ESSENTIAL FOR LIMITING RESIDUAL QUANTITIES AT THE END OF TREATMENT.

NIVELEC AND NIVOMATIC GAUGES PROVIDE EVEN MORE ACCURATE READINGS AND COMFORT; THE VOLUME IS DISPLAYED ON A CONTROL BOX INSIDE THE CABIN.

Four models of gauge are available. In its standard version, the Elyte is equipped with a direct read-out gauge. As an optional extra, it can be fitted with a rotary drum gauge or Nivelec and Nivomatic electronic gauges. Placed on the front of the unit, the new Berthoud rotary drum gauge is accurate and easy to read from both the cabin and the filling station.



With the Nivomatic gauge a given volume can be programmed when filling. Once the volume has been attained, the gauge can either set off an audible alarm or stop the filling operation. An efficient solution for avoiding any accidental overflows.

RINSING THE BOOM WITH CLEAN WATER

With the Elyte, in-the-field rinsing is made easy by

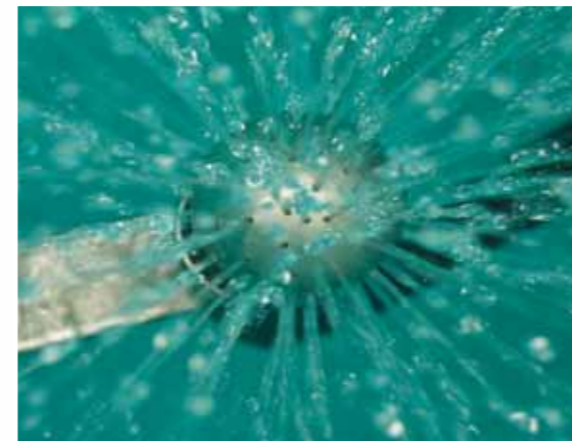

The final rinsing of the spray circuit can be done using clean water. Water pumped into the rinsing tank is then sent to the tank via rinsing balls or to the boom without any return line back to the tank. This system also enables to rinse the machine if the spraying operation has to be stopped. The "automatic rinsing" option enables to control these operations from the tractor cab.

The two rinse circuit ball valves on either side of the main tank for high-performance rinsing.



REDUCING RESIDUAL VOLUMES



The main tank on the Elyte possesses a sump with a lateral draw-off tap for complete draining before the pump is no longer primed.

The piping, channelled through the central arm, is shorter, which means less residual volume.

Precision spraying

THE RIGHT DOSE AT THE RIGHT MOMENT IN THE RIGHT PLACE, IN SHORT, THE SPRAYING OPERATION'S OBJECTIVE. THE ACCURACY OF THE SPRAY-CONTROL SYSTEM PLAYS A VITAL ROLE IN THIS CONTEXT. IT IS ALSO A DECIDING FACTOR FOR REDUCING VOLUMES LEFT OVER AFTER SPRAYING. THREE TYPES OF CONTROL SYSTEM ARE OFFERED FOR THE ELYTE: THE AUTOREGULATOR, THE DP CONTROL AND THE DP TRONIC.

Regulation

AUTOREGLEUR DPM

AUTOREGULATOR is a DPM (Flow Proportional to Engine speed) regulation unit. This system allows you to maintain a constant volume/ha in a selected gear ratio; it is very precise for speed variations of up to 20%.

- > Simple and economic solution
- > DP CONTROL option for a permanent display of the 4 main spraying parameters (vol/ha applied, forward speed, litres sprayed, calculated pressure)
- > BERJUST 2000 option: This monitor can be used to alternately display volume/ha applied and forward speed. If necessary, it can also display the number of litres sprayed, the hectares sprayed and the kilometres travelled.

DP TRONIC and eC TRONIC : electronic regulations via pressure sensor

Regulation by a pressure sensor offers several advantages:

- > Improved accuracy (pressure measurement close to the nozzle and more efficient on smaller volumes)
- > Not affected by clogging or blocking
- > No calibrated returns
- > Reduced maintenance
- > Closing of nozzle/nozzle requires no change in setting

DP TRONIC monitor is used to:

- > Control spraying and the boom
- > Adjust the volume/ha
- > Permanently display the 4 main spraying parameters (Volume/ha, speed, litres sprayed, pressure measured)
- > Display individual totals which can be stored for 10 plots
- > Suitable for precision agriculture

DP Tronic advantages

- > Start-up pressure
- > Minimum pressure during spraying (pressure threshold)
- > Adjustment of the dose during application within DPE mode
- > May be used with a multi-function gun for increased working comfort



eC TRONIC monitor

It is used to:

- > Permanently display the 4 main spray parameters (volume/ha, speed, litres sprayed, pressure measured)
- > Integrates certain options: weather station, etc.
- > Traceability (by plot, multi-users, etc.)
- > Individually control 15 sections sequentially on the multi-function joystick

eC Tronic advantages

- > BUS CAN technology
- > Large 15 cm colour screen
- > ePILOT wireless multi-function joystick (standard in ED, optional in SEH): work within a radius of up to 25 m from the central unit to check any blocking of the nozzles, the adjustment of the booms, the measurement of the nozzle flow from outside!



DP TRONIC monitor



Pumps

GAMA pump

Reputed for its sturdiness and long service life, Gama piston pump (101, 130 or 160 l/min) possesses two major advantages:

- > Excellent volume measurement, which guarantees the accuracy of the DPM regulation systems (Autoregulator and DP Control)
- > Minimum servicing requirements thanks to its oil-bath mechanism, the use of stainless steel valves and the absence of an air chamber.



Diaphragm piston pump (in option)

- > 280 l/min - 20 bar
- > Simple and economic

GPS assistance

eTECH or eTECH Visio units: a turnkey solution!

The BERTHOUD regulation units may be fitted with eTECH or eTECH Visio units for guiding and separating sections. Touch-screen console with the same level of functions, available with 2 screen sizes, 5"7 or 8"4.



These solutions allow:

- > Guiding
- > Separation of sections by GPS with display of the state of the sections (closed/open) and the zones worked on in single, double or triple passes. As each application requires a different level of precision, BERTHOUD GPS solutions are supplied as standard with a EGNOS receiver (free signal - 15-30 cm), and other reception levels are available optionally to increase the precision.

Circulation of spray mixture

Discontinuous circulation: The basis

The spray mixture flows in the sections only when spraying, no return to the tank at the end of the section.

Semi-continuous circulation (optional):

ELYTE can also be fitted with semi-continuous flow. This system allows a continuous flow of the liquid during spraying to avoid clogging at the end of the sections.

Continuous circulation (optional):

This ensures that the spray mixture flows during and after spraying. Based on an AGP (Pneumatic Anti-Drip) system, it provides various advantages:

- > Minimises dirt and deposits
- > Permanent agitation
- > The rinsing water may be used several times by "recirculating" it = less contaminated water to be evacuated
- > Rapid start-up
- > Instantaneous pneumatic cut-out

Axiale & Elyte perfect harmony

TODAY, THE REPUTATION OF AXIALE BOOMS, WHICH HAVE ALREADY BEEN THOROUGHLY TESTED ON BERTHOUD TRAILED UNITS, IS WELL ESTABLISHED.

REMARKABLE STABILITY

- remarkable vertical stability especially on turns and a very good performance on hillsides thanks to its central pivot suspension system.
- no whipping due to the rigidity of its triangulated structure.
- slope correction and variable geometry available on option.



ROBUSTNESS

Robustness of the link points, long service life for the hydraulic cylinders, which work with their shafts retracted when the boom is in an unfolded position



Quadrix nozzle holders protected in front and behind



Foldaway boom ends



A CENTRAL PIVOT SUSPENSION SYSTEM

The Axiale boom is mounted on a central pivot close to its centre of gravity. The boom's balance and parallelism in relation to the tractor axle is provided by four return springs placed between the fixed and mobile frames. Vibrations are dampened by two shock absorbers.

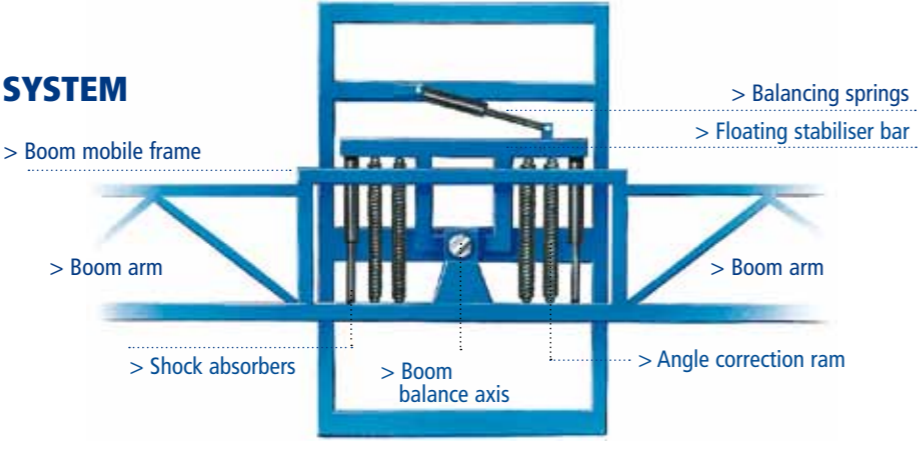

DIMENSIONS

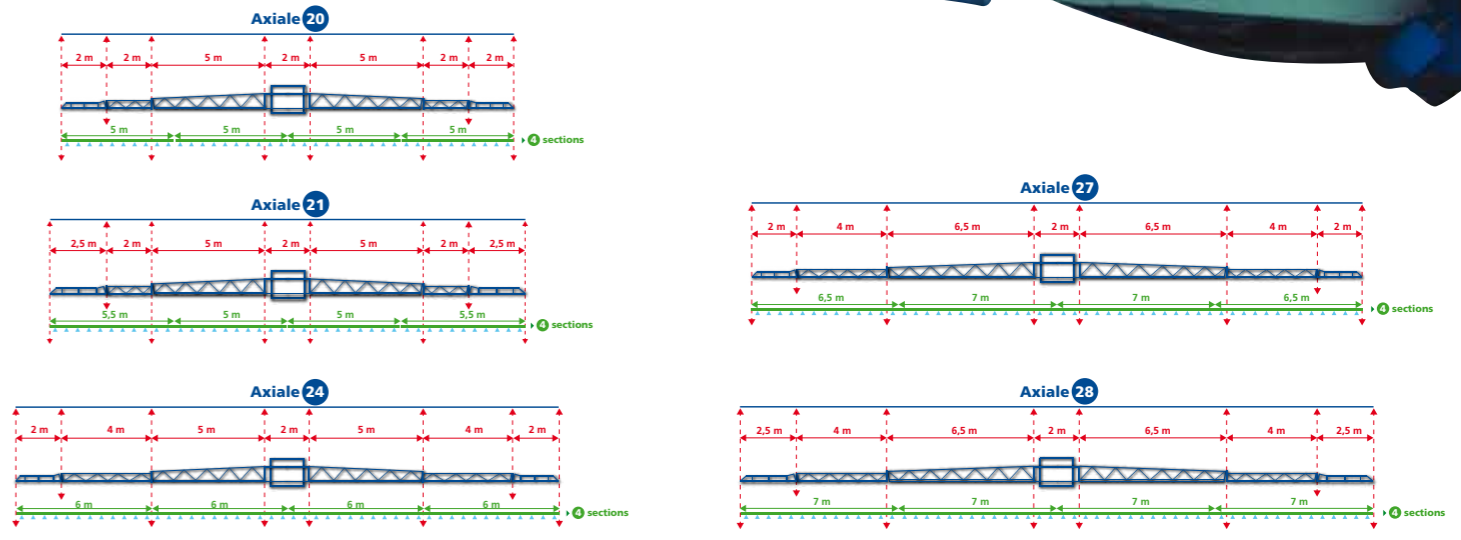

FOLDING UP AND UNHITCHING

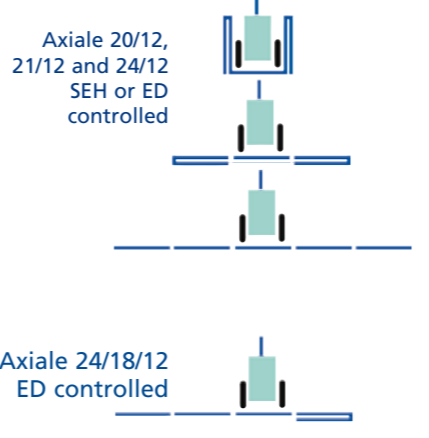

AXIALE AND ELYTE, AN IDEAL COMBINATION

- the "nitrogen ball" suspension system for the lifting arm improves shock absorbing and takes weight off the boom structure.
- the height and slope indicators on the front of the unit make operation easier.



Ulys & Elyte

DESIGNED FOR ALL TYPES OF FARMING, THE ULYS REAR-FOLDING BOOM OFFERS A NUMBER OF ADVANTAGES: REDUCED SIZE, EASY ACCESS TO THE CAB AND MANHOLE, STURDY STRUCTURE, REMARKABLE STABILITY.

REMARKABLE STABILITY THANKS TO ITS AXIAL SUSPENSION SYSTEM

- ⊕ Excellent stability on turns and slopes thanks to its pivot suspension system
- ⊕ Slope corrector available as standard and variable geometry optionally

A specific suspension:

Axial suspension on a central pivot with 4 return springs and 2 shock absorbers. Specific anti-whipping system made up of 2 silentblocks and a shock absorber on the central pivot increasing the service life of the boom structure.

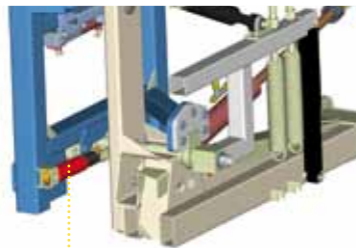

Shock absorbers

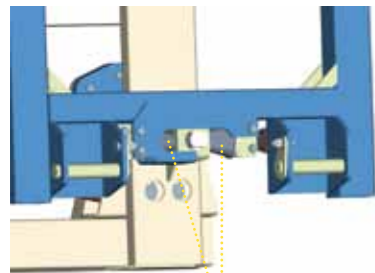

Silentblocks

Extra sturdiness



Folded metal frame with integrated spray circuit, nozzle holder and nozzles.



maximum compactness

CONTROL USING TRACTOR DISTRIBUTORS, SEH OR ED

Tractor distributor version (1SE and 2DE)

- ⊕ Complete unfolding and locking
- ⊕ Slope corrector

Electro-Hydraulic Selector version (1SE and 1DE)

- ⊕ Unfolding of the boom
- ⊕ Locking
- ⊕ Slope corrector

Electro-Distributors version (1SE and free return)

- ⊕ Complete or independent unfolding
- ⊕ Locking
- ⊕ Slope corrector
- ⊕ Variable geometry



Cylinders work with their shafts retracted when the boom is in an unfolded position: locking of link points, no whipping of the arms, protection of the cylinders.



Breakaway boom ends at the front and the rear

Successive unfolding of arms using hydraulic contactors.



FOLDING AND LAYOUT: multiple options to meet your requirements

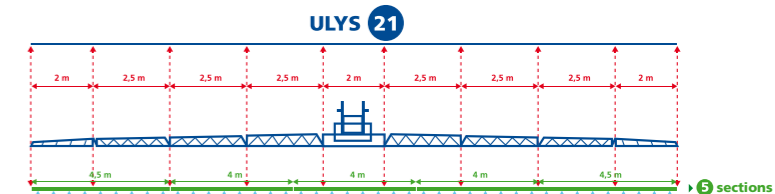
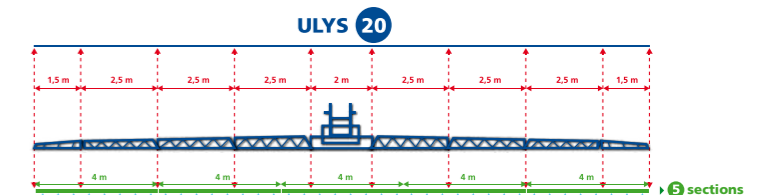
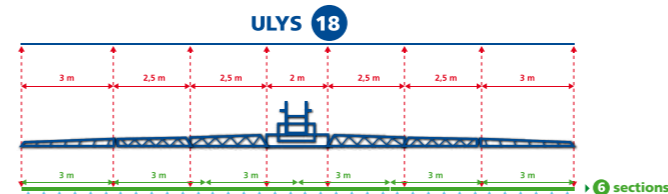

MULTIS & RLD booms

with simple and efficient structures

RLD BOOM

- ⊕ Tubular structure protected by Berthoud Ultra-High Resistance paint
- ⊕ Four boom models: 18, 20, 21 and 24 m
- ⊕ Hydraulic side-folding
- ⊕ Suspension with two or four hillside links
- ⊕ Lift on central arm

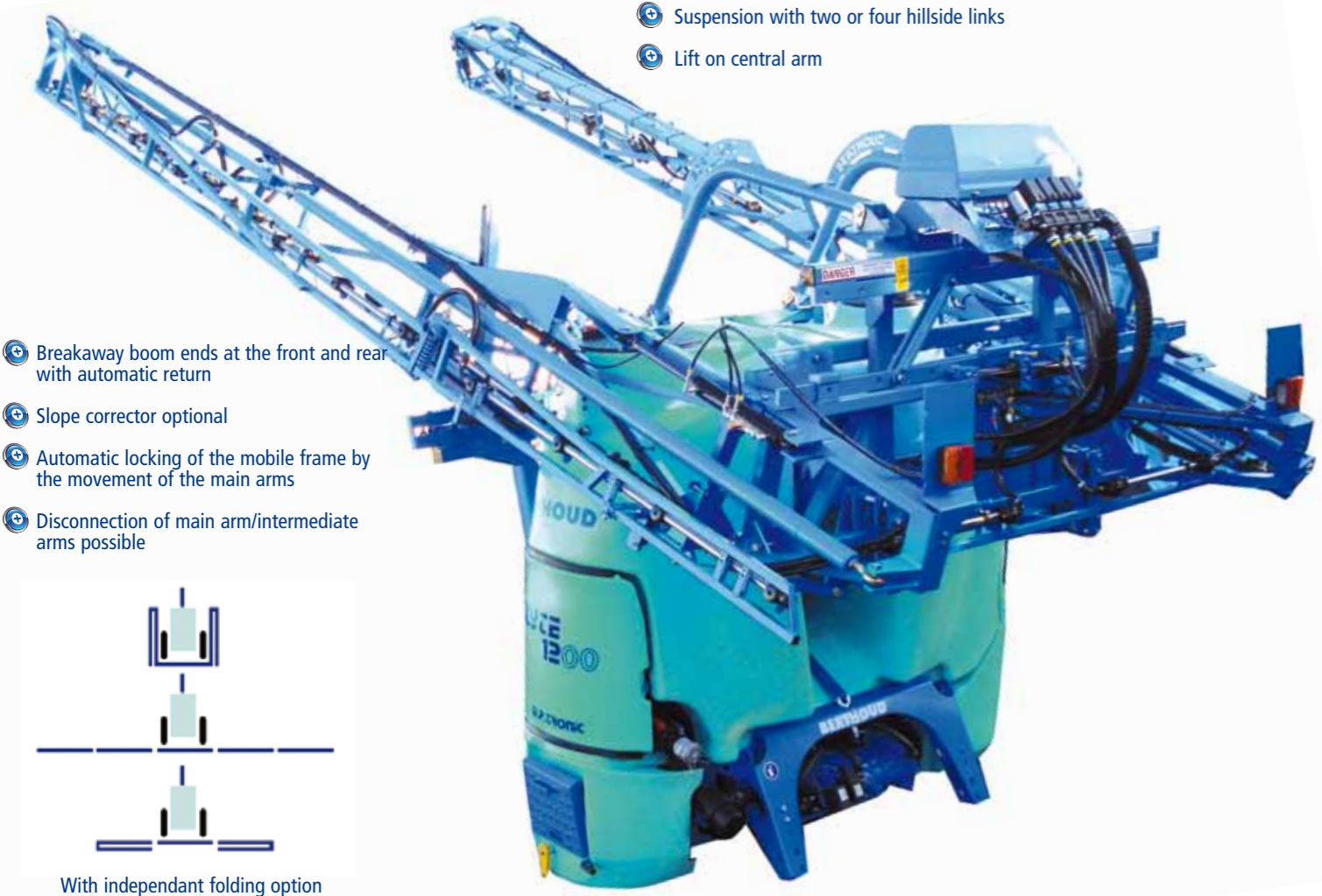

- ⊕ Breakaway boom ends at the front and rear with automatic return
- ⊕ Slope corrector optional
- ⊕ Automatic locking of the mobile frame by the movement of the main arms
- ⊕ Disconnection of main arm/intermediate arms possible

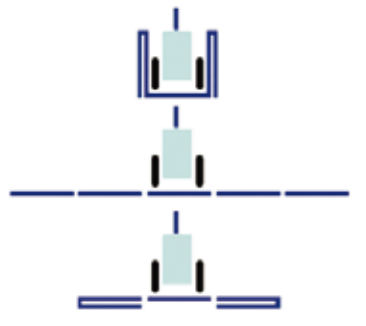

With independent folding option

⊕ Rigid PVC pipes, stainless steel optionally, protected QUADRIX nozzle holder

FOLDING AND LAYOUT

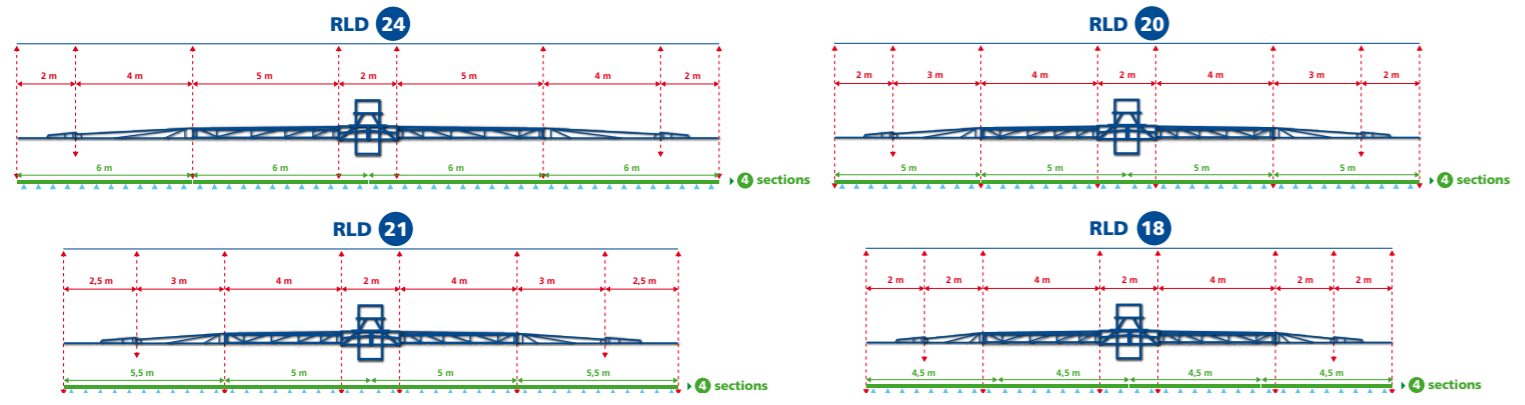

MULTIS BOOM

REAR-FOLDING BOOM 15 AND 18 M. COMPACT AND LIGHTWEIGHT, THE MULTIS BOOM OFFERS A NUMBER OF ADVANTAGES

Multi-purpose

Designed for mixed farming, livestock breeders and vegetable growers, it offers maximum compactness and great flexibility for folding/unfolding the arms.

Compact and lightweight

With an extremely reduced clearance, it makes driving on roads and winter storage very easy and is suitable for all types of tractors.

Modular

Disconnection of the arms for flexibility of use.

Sturdy

Protection of the boom by Berthoud UHR paint or galvanisation, front and rear protections of nozzle holders, breakaway boom ends.

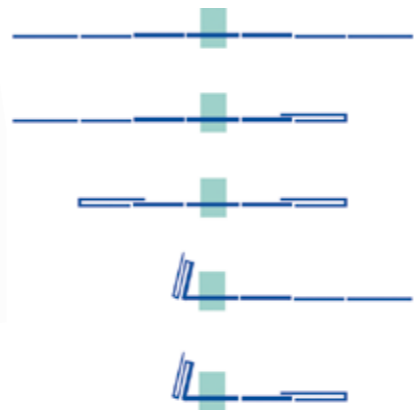

- ⊕ Unfolding of the arms using 4 double-acting cylinders and slings
- ⊕ Slope corrector optional
- ⊕ Boom suspension using two links
- ⊕ Automatic locking of the mobile frame by the movement of the main arms
- ⊕ Lift on central arm



FOLDING AND LAYOUT

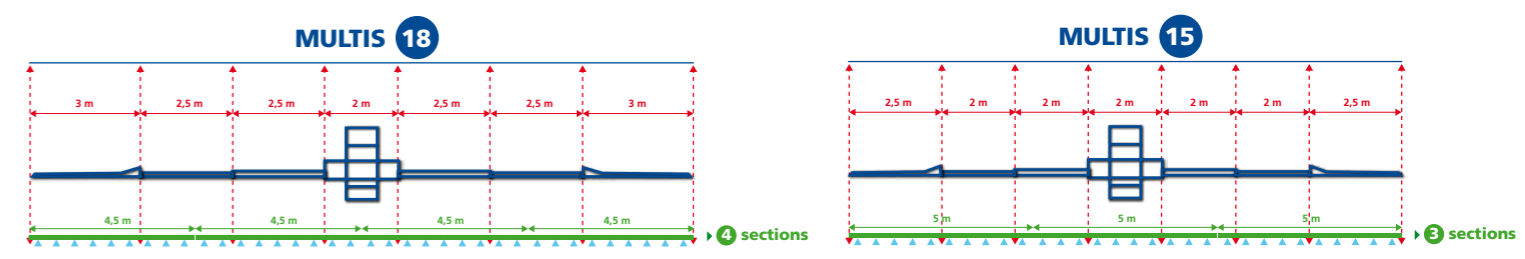

ELYTE ELYPSE boom

the innovative folding

DEVELOPED BY CAPITALISING ON BERTHOUD'S EXPERIENCE, THE ELYPSE BOOM OFFERS AN INNOVATIVE FAN FOLDING SYSTEM THAT LIMITS THE SIZE IN FOLDED POSITION, THEREBY SIGNIFICANTLY REDUCING THE OVERHANG.

An innovative folding concept

- Fan folding of arms
- Innovative concept for limiting the boom size



Exceptional stability

- Remarkable vertical stability especially on turns and a very good performance on hill-sides thanks to its central pivot suspension system.
- Slope corrector available as standard and variable geometry optionally

STRUCTURE AND SECTIONS LAYOUTS

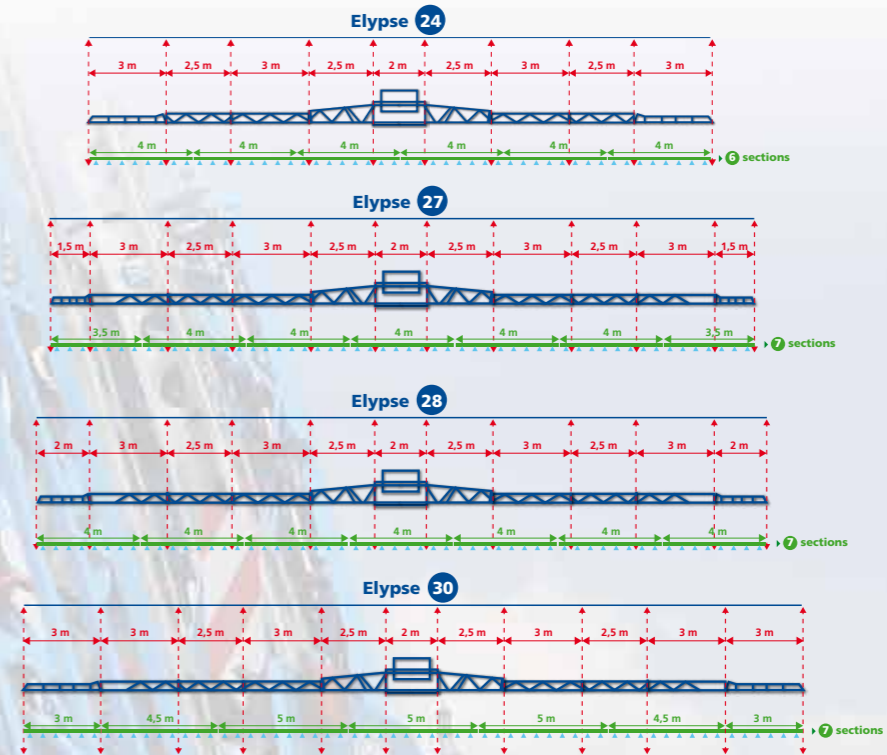

Sturdiness of the AXIALE structure

- Triangulated arm structure made of steel, the last arm in aluminium profile
- Limited whipping thanks to the triangulated structure
- Pipes, nozzles and nozzle holders integrated into and protected in the boom structure
- Robustness of link points, long service life of the cylinders which work with their shafts retracted when the boom is an unfolded position

Hydraulic controls

Electro Hydraulic Selector version (1SE and 1DE)

- Complete or independent unfolding of the boom
- Locking of the suspension
- Slope corrector

Electro Distributors version (1SE and 1 free return)

- Complete or independent unfolding of the boom
- Locking of the suspension
- Slope corrector
- Variable geometry

BOOM CONTROL: the most efficient system on the market

BERTHOUD's automatic boom height regulation system, BOOM CONTROL, is available optionally on all of our machines equipped with electro distributors. The BOOM CONTROL system maintains the boom at a height preset by the user. Two versions are available:



SLANT CONTROL version

The SLANT CONTROL version controls the boom height and slant automatically

TOTAL CONTROL version

The TOTAL CONTROL version controls all the boom functions: height, variable geometry, even slant (depending on the boom type)

Features & equipment

	Elyte Autoregleur			Elyte DP Tronic EC Tronic		
	1000	1200	1600	1000	1200	1600
Automatic hitching	X	X	X	X	X	X
125 l rinsing tank	X	X		X	X	
165 l rinsing tank			X			X
Storage compartment	X	X	X	X	X	X
16 l hand wash tank	X	X	X	X	X	X
Mixing hopper	X	X	X	X	X	X
Berlogic panel	X	X	X	X	X	X
Direct read-out gauge	X	X	X	X	X	X
Drum gauge	Option	Option	Option	Option	Option	Option
Nivelec gauge	Option	Option	Option	Option	Option	Option
Nivomatic gauge	Option	Option	Option	Option	Option	Option
Filling filter (8/10 mm)	X	X	X	X	X	X
Suction filter (6/10 mm)	X	X	X	X	X	X
Pressure filter (4/10 mm)	X	X	X	X	X	X
Agitation by return of unsprayed liquid to the tank and hydromax	X	X	X	X	X	X
Ball valves for rinsing	X	X	X	X	X	X
Electric tank and boom rinsing controls	Option	Option	Option	Option	Option	Option
GAMA 101 pump	Standard for Multis booms					
GAMA 130	Option (standard for RLD - ULYS - AXIALE - ELYPSE 24 booms)					
GAMA 160	Option (Standard for ELYPSE booms 28 to 30 m)					
Diaphragm pistons BP 280 (280 l/min - 20 bar)	Option					
VEC	X	X	X	X	X	X
Autoregleur control (DPM)	X	X	X			
Berjust 2000 (power-assisted DPM)	Option	Option	Option			
DP Control (power-assisted DPM)	Option	Option	Option			
DP Tronic (DPAE)				X	X	X
EC TRONIC (DPAE)				X	X	X
MULTIS boom	X					
RLD boom	X					
AXIALE boom	X (28 m version only on ELYTE 1600)					
ULYS boom	X					
ELYPSE boom	X					
BOOM CONTROL	Option					
Semi-continuous flow						Option
Continuous flow with AGP						Option
Boom lighting	Option on AXIALE - ULYS - ELYPSE					
External washing	Option					

Dimensions in m		Multis 15	Multis 18	RLD 18/20	RLD 21	RLD 24	Axiale 21	Axiale 24	Axiale 28	Ulys 18	Ulys 20/21	Elypse 24	Elypse 30
ELYTE 1000	A	2,55	3,05	3,68	3,68	3,83	4,20	4,20	4,66	3,52	3,06	3,17	3,26
	B	2,51	2,51	2,23	2,23	2,38	2,55	2,55	2,55	2,55	2,55	2,55	2,55
	C	1,90	1,90	4,26	4,76	4,50	4,90	5,20	6,95	1,89	1,89	1,68	1,68
	D			1,77	1,77	1,88	1,75	1,75	1,75				
ELYTE 1200	A	2,55	3,05	3,68	3,68	3,83	4,20	4,20	4,66	3,52	3,06	3,17	3,26
	B	2,51	2,51	2,23	2,23	2,38	2,55	2,55	2,55	2,55	2,55	2,55	2,55
	C	1,90	1,90	4,26	4,76	4,50	4,90	5,20	6,95	1,89	1,89	1,70	1,68
	D			1,77	1,77	1,88	1,75	1,75	1,75				
ELYTE 1600	A	2,55	3,05	3,68	3,68	3,83	4,20	4,20	4,66	3,57	3,11	3,10	3,19
	B	2,51	2,51	2,23	2,23	2,38	2,55	2,55	2,55	2,55	2,55	2,55	2,55
	C	2,00	2,00	4,26	4,76	4,50	4,90	5,20	6,95	2,15	2,15	1,62	1,76
	D			1,77	1,77	1,88	1,75	1,75	1,75				

Weight in Kg		Multis 15	Multis 18	RLD 18/20	RLD 21	RLD 24	Axiale 21	Axiale 24	Axiale 28	Ulys 18	Ulys 20/21	Elypse 24	Elypse 30
ELYTE 1000	TW	960	986	1100	1145	1190	1470	1490	1580	1340	1370	1510	1580
	PTAC	2204	2220	2350	2385	2440	2700	2720	2965	2565	2595	2660	2725
ELYTE 1200	TW	970	996	1109	1160	1220	1480	1500	1600	1350	1380	1520	1590
	GVW	2434	2460	2525	2565	2625	2930	2950	3365	2785	2815	2870	3025
ELYTE 1600	TW	1070	1100	1260	1310	1370	1580	1600	1700	1500	1530	1680	1745
	GVW	2840	2870	3155	3205	3265	3345	3365	3465	3400	3430	3450	3645

TW: empty weight
GVW: Gross vehicle weight

AXIALE boom type size

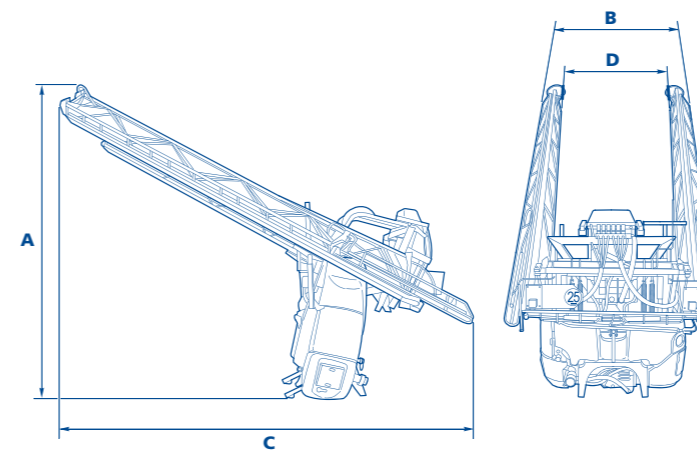

MULTIS boom type size

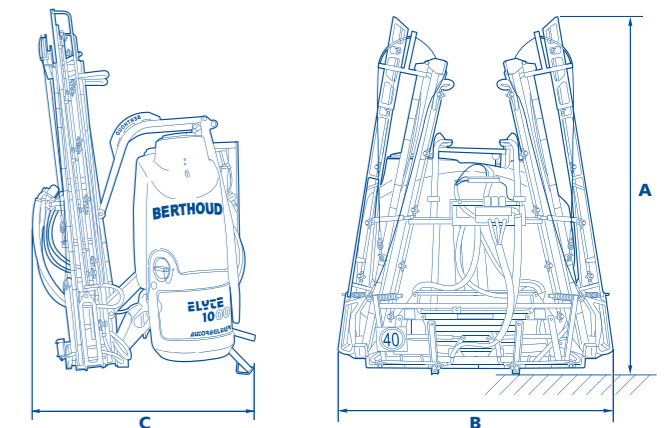

ELYTE 100% BERTHOUD

BERTHOUD, a history that goes back to 1895 on an initiative by Paul BERTHOUD. In 1987, the brand joined the Exel Industries group, the world leader in spraying techniques present in the agricultural, industrial and general public fields. BERTHOUD generates its turnover with row crops, vines and trees.



Range advantage

BERTHOUD meets all requirements: multi-crop-livestock farming, cereals, large farm holdings, ETA, Cuma... From the simplest machine (mechanical DPA), to e BERTHOUD SOLUTIONS, (precision agriculture), they all benefit from the best resale value on the used machine market.



Innovation advantage

BERTHOUD designs all of its sprayers and over 10% of its employees work on Research & Development. BERTHOUD proposes its own concepts and had many patents: ACTIFLEX...



Network advantage

A special partnership of over 50 years with a network that provides a relay close to your location. 350 dealership technicians are trained every year in our Training Centre.



Service advantage

Delivery of spare parts in less than 24 h, delivery performance of almost 99 % strengthened by the great availability of our teams on the road and the performance of our After Sales hot line .

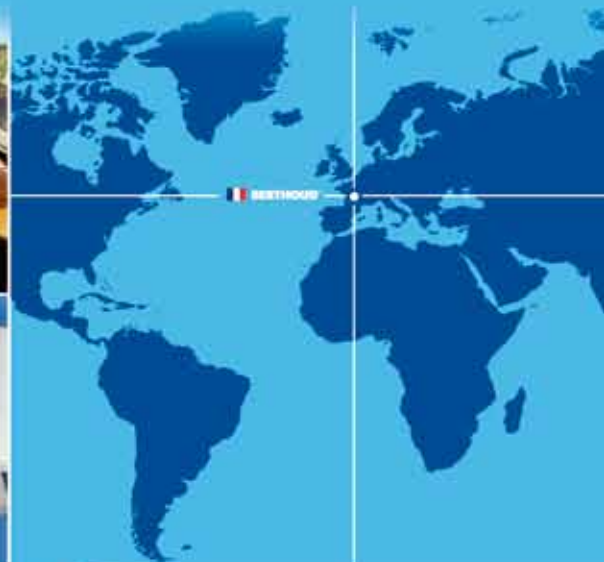

85911 BE 10/13